



— Gutter systems & Trapezoidal sheets —

Product Catalogue

- Gutter Systems
- Profiled Sheet Metal
- Services and other Products



AL - Dy dekadat e fundit ndërmarrja prodhuese Alush Lim me një vndë pune mbi 1000 m² është adresa e vetme e prodhimit kualitativ të sistemeve të ULLUQEVE si dhe profilimin e llamarinës në formë Trapezoidale dhe Sinuzoidale

Gjithashtu me personelin e specializuar bën montimin dhe demontimin e po të njejtave elemente. Falë maqinerisë dhe pajisjeve më të sofistikuara të kësaj lëmie jemi ndër pajisësit e rrallë për prodhimin e elementeve të sistemit të Ulluqeve dhe Profilimit të llamarinës në R. Maqedonisë. Qëllimi kryesorë i kompanisë është Zhvillimi konstant i produkteve, përparimi, zgjerimi i tregut, kapacitetit të produkteve si dhe rritja e numrit të punësuarve.

МКД - Последните две децении, производната компанија Алуш Лим е единствена адреса за производство на целосниот систем за Олуци и профилирање на лимови во трапезна форма и сисусна форма. Исто така Алуш Лим со својот професионален персонал врши монтажа на своите производи. Алуш Лим по техничка опременост и машинерија е меѓу најдобрите во овој бизнис во цела Македонија. Нашите производи се продаваат и дистрибуираат низ цела Македонија. Нашите производи се разликуваат со висок квалитет, сето тоа е поврзано со нашето долгогодишно искуство во ова област чии почтоци се од запад.

ENG - On the last two decades Alush Lim has become the only destination for the production of Profiled sheet metal as Trapezoidal and Sinusoidal also produces the whole range of guttering system

. Our products include a whole range of component elements starting from gutters up to the tiniest metallic elements which are used and utilized in completing modern buildings.

Alush Lim has highly specialized personnel for fixing and dismantling the above mentioned component elements.

Thanks to the most sophisticated machinery and equipments it owns, Alush Lim is among the most important suppliers of profiled sheet metal and guttering systems in the Republic of Macedonia. Our products are distributed almost in all towns of Macedonia.



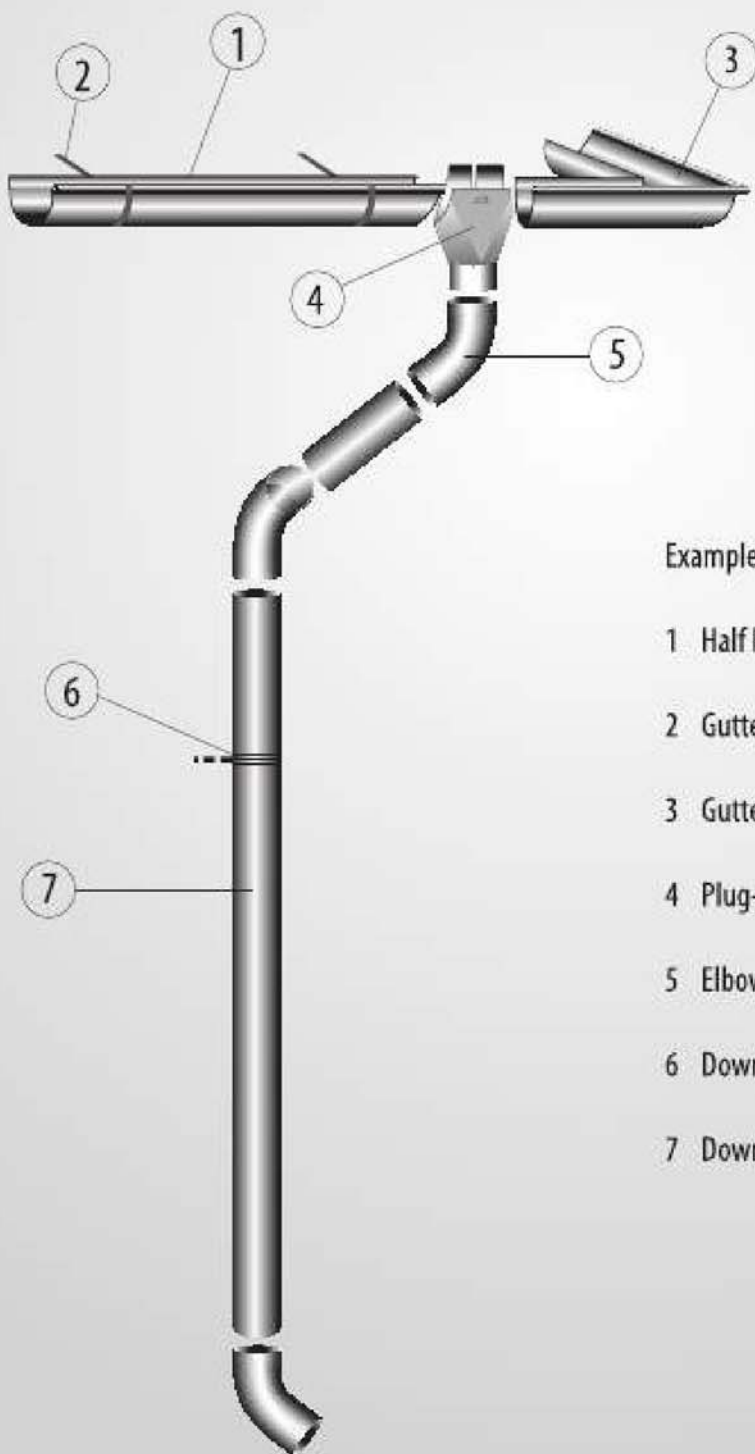

Example:

- 1 Half Round Gutter
- 2 Gutter Brackets / Snap-lock system
- 3 Gutter Corner
- 4 Plug-in gutter outlet
- 5 Elbow
- 6 Down pipe bracket
- 7 Down pipe



• Ulluk horizontal / Хоризонтален Олук / Horizontal Gutter

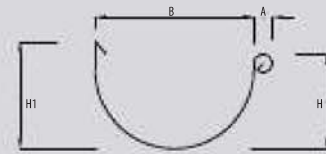

-  ral 3009
-  ral 8017
-  ral 8019
-  ral 9006
-  ral 9002
-  (Zn) zing

	A	H	B
330 mm	18 mm	90 mm	150 mm
280 mm	18 mm	70 mm	120 mm

• Mbajtëse për ulluk / Држач за олук / Gutter Hook

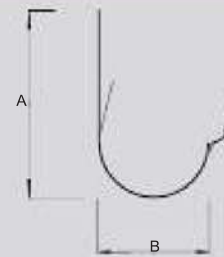

-  ral 3009
-  ral 8017
-  ral 8019
-  ral 9006
-  ral 9002
-  (Zn) zing

	A	B
330 mm	410 mm	150 mm
280 mm	330 mm	120 mm

• Ext. & Int. Kthesë për ulluk / Кош за олук / Gutter Corner

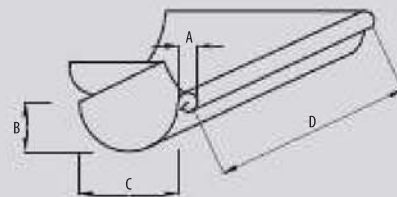

-  ral 3009
-  ral 8017
-  ral 8019
-  ral 9006
-  ral 9002
-  (Zn) zing

	A	B	C	D
330 mm	18 mm	90 mm	150 mm	310 mm
280 mm	18 mm	70 mm	120 mm	300 mm

• Kapak për ulluk / Капак за олук / Gutter Stop End



/
330 mm
280 mm

-  ral 3009
-  ral 8017
-  ral 8019
-  ral 9006
-  ral 9002
-  (Zn) zing

• Gyra Vertikale / Вертикален олуk / Round DownSpout



Ø
75 mm
80 mm
100 mm
120 mm
150 mm

-  ral 3009
-  ral 8017
-  ral 8019
-  ral 9006
-  ral 9002
-  (Zn) zing

• Kthesa / Колена / Elbow

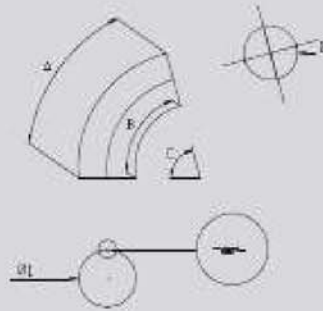

Ø
80
100
120

-  ral 3009
-  ral 8017
-  ral 8019
-  ral 9006
-  ral 9002
-  (Zn) zing

• Shtusna / Штуцна / Plug In Outlet



mm
150 / Ø100
150 / Ø80
120 / Ø80

-  ral 3009
-  ral 8017
-  ral 8019
-  ral 9006
-  ral 9002
-  (Zn) zing

• Stega / Стера / Bracket



Bracket with screw 100 mm	Ø100 / Ø80
Bracket with screw 180 mm	Ø100 / Ø80

-  ral 3009
-  ral 8017
-  ral 8019
-  ral 9006
-  ral 9002
-  (Zn) zing

Llamarinë e profilar / Профилирани лимови / Profiled Sheets

AL T - 15 / 225 / 900 / 1125



AL T - 25 / 205 / 820 / 1025

AL S - 18 / 76 / 864 / 1064

AL L - 3 / 70 / 270

AL - Double standing seems

Protective layer of standard PPG sheets.

-  Polyester Coating 20 mic
-  Primer 7 mic
-  Zinc Coating 140g/m²
-  Steel Base DX51 0.50mm



МКД - Сите материали што Алуш Лим ги користи се атестирани за квалитет И технички карактеристики што гарантира потекло, физички И хемиски својства на лимот.

Дебелина на лимот варира од 0.40мм до 0.70.

Максимална должина на производство е 13,50 м

AL - Të gjitha materialet që Alush Lim përdor janë të atestuar për cilësinë dhe karakteristikat teknike të cilat garantojnë origjinën, vetitë fizike dhe kimike të Llamarinës.

Trashësia e llamarinës dallon nga 0.40mm në 0.7 mm.

Max. gjatësia e prodhimit është 13.50 m

ENG - All the material that Alush Lim uses have a unique attest of quality and technical characteristics witch guarantee the origin , physical and chemical properties of sheet metal.

Thickness of the steel is from 0.40mm to 0.7 mm.

The max. length of the production is 13.50 m

-  ral 3009
-  ral 8017
-  ral 8019
-  ral 9006
-  ral 9002
-  (Zn) zing

AL L-3 / 70 / 270

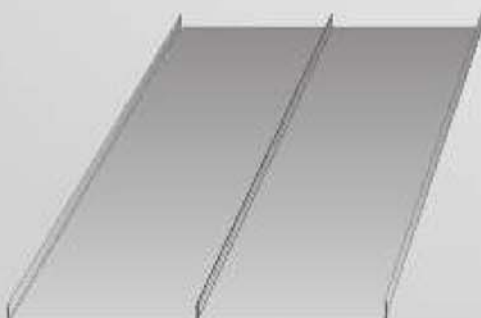
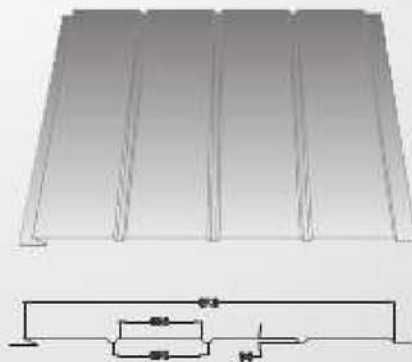

Folded double standing seems



-  ral 3009
-  ral 8017
-  ral 8019
-  ral 9006
-  ral 9002
-  (Zn) zing

AL S - 18 / 76 / 1064

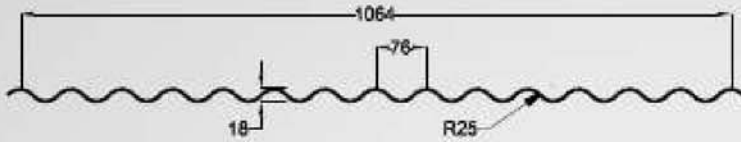

-  ral 3009
-  ral 8017
-  ral 8019
-  ral 9006
-  ral 9002
-  (Zn) zing

AL T - 15 / 225 / 900 / 1125

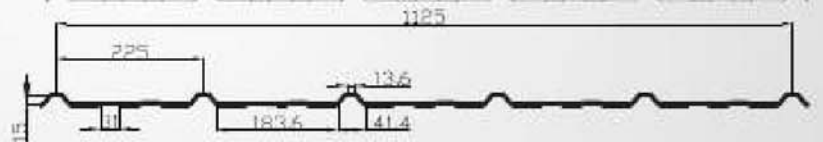

AL T - 25 / 205 / 820 / 1025

-  ral 3009
-  ral 8017
-  ral 8019
-  ral 9006
-  ral 9002
-  (Zn) zing

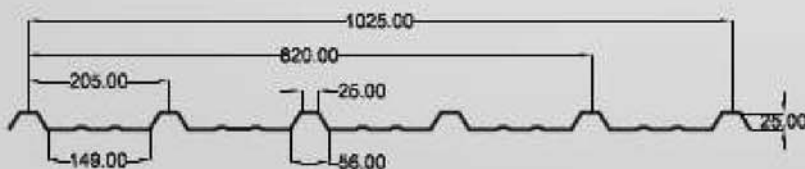

- Dritare / Прозор за кров / Roof Window



- Mbrojtse për borë / Снегобран / Snow Guards



- Kantë për mbeturina / Канта за ѓубре / Recycle Bin

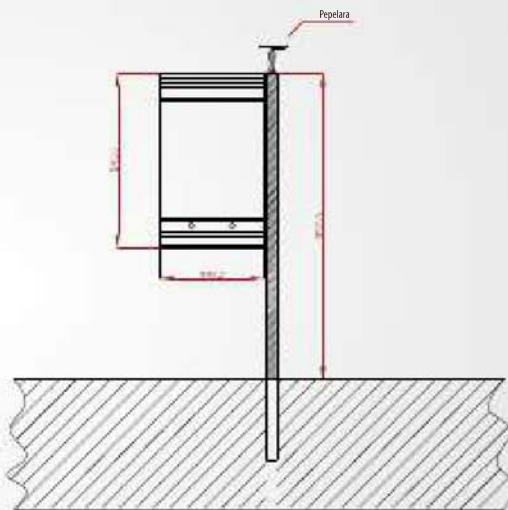

- Kotorlac 5 T / Одмотач 5 T / Un-coiler 5 T



• Max. Load	5 Ton
• Material Width	1000mm - 1250mm
• Coil Inner diameter Min.	450 mm
• Coil Inner diameter Max.	650mm

Shërbimet dhe produktet tjera / Услуги и други производи / Services and other products

Виткање - Нашите абкант машини може да виткаат алуминиумски лимови до 2мм, челични лимови до 0.7мм дебелина и 6.2м должина. Можеме да виткаме разни профили по предвидени цртежи.

LAKIMI - Makinat për lakim që i kemi mundet të lakojnë llamarinë të aluminit deri 2mm, llamarinë të çelikut deri 0.7mm dhe gjatësi deri në 6.2m. Ne mundet të bëjmë lakim sipas vizatimeve të ofruara.

BENDING - Our bending machines can easily form aluminum sheets up to 2 mm, steel sheets up to 0.7 mm thickness and 6,2 m long. We can make custom bending profiles according to provided drawings.

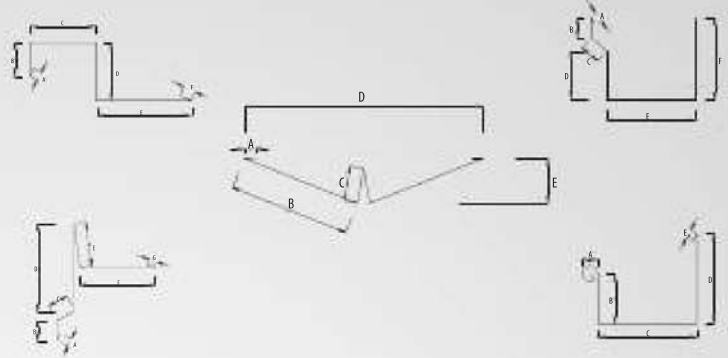

ТРАНСПОРТ И ИНСТАЛАЦИЈА - Ги дистрибуираме нашите производи низ цела Македонија со нашите моторни возила. Истотака нашиот професионален персонал вршме инсталација на нашите производи со 2 години гаранција.

TRANSPORTI DHE INSTALIMI - Ne mund të dorëzojmë produktet Alush Lim në vende anembanë Maqedonisë nga ana jona Përveç kësaj, ekipet tona me përvojë mund të bëjnë instalimin e produkte Alush Lim me garancion prej 2 vitesh.

TRANSPORT AND INSTALLATION - We can deliver Alush Lim products on sites across Macedonia by our own or vehicles owned by our partners. In addition, our experienced teams of roofers can install Alush Lim products with 2 year installation guarantee.



ЕЛЕКТРОСТАТСКО ФАРБАЊЕ - Алуш Лим содржи опрема за електростатско фарбање. Се фарбаат некои производи кои се користаат во покриви.

NGJYROSJE ELEKTROSTATIKE - Alush Lim posedon mjet për ngjyrosje elektrostатике e cila perdoret për ngjyrosjen e disa elemteve që përdoren në kulmë.

ELECTROSTATIC COATING - Alush Lim contains it's own electrostatic powder coating equipment for painting the products that are used for roofing and etc.





ГРЕАЛКИ ЗА ОЛУК - Ние нудиме греалки за олук во различни должини.

NXEMJE PER ULLUQE - Ne ofrojmë nxemje per ulluqe në gjatësi të ndryshme.

GUTTER HEATER - We offer gutter heater in different dimensions

СИСТЕМИ ЗА ОЦАК - Ние нудиме надворешни Иноксни оцаци со изолација до 120kg/m^3

SISTEMET E OXHAKUT - Ne ofrojmë sisteme për oxhak të jashtëm prej materialit Inox dhe me izolim prej 120kg/m^3

FLUE AND CHIMNEY SYSTEMS - We offer Double wall chimney systems from Stainless steel with rock wool insulation of 120kg/m^3 in different dimensions



ДОДАТОЦИ - Ние нудиме завртки за соодветни димензии за профилирани лимови, WURTH силикони, WURTH ножици и спрејови за корекција

AKSESORE - Ne ofrojmë shtrafa të përshtatçme për profile që l kemi. Produktet ngjitetëse WURTH, Gërshtëre WURTH si dhe ngjyra korigjuese.

ACCESSORIES - We offer fasteners of adequate dimensions for profiled sheets, Wurth product line of sealants, Wurth Sheet Metal Shears, corrective spray paints.





